

225mA, 350V SMD Switching Diode

FEATURES

- Fast switching speed
- Ideal for automated placement
- High surge current capability
- Moisture sensitivity level: level 1, per J-STD-020
- RoHS Compliant
- Halogen-free according to IEC 61249-2-21

APPLICATIONS

- Switching mode power supply (SMPS)

KEY PARAMETERS		
PARAMETER	VALUE	UNIT
I_F	225	mA
V_{RRM}	350	V
I_{FSM}	4	A
V_F at $I_F=200mA$	1.25	V
$T_{J\ MAX}$	150	°C
Package	SOT-23	



MECHANICAL DATA

- Case: SOT-23
- Molding compound meets UL 94 V-0 flammability rating
- Terminal: Matte tin plated leads, solderable per J-STD-002
- Meet JESD 201 class 1A whisker test
- Weight: 8 ± 0.5 mg (approximately)



ABSOLUTE MAXIMUM RATINGS ($T_A = 25^\circ\text{C}$ unless otherwise noted)				
PARAMETER		SYMBOL	VALUE	UNIT
Marking code on the device	MMBD3004		HC	
	MMBD3004CA		RA	
	MMBD3004CC		PZ	
	MMBD3004SE		PY	
Power dissipation		P_D	350	mW
Repetitive peak reverse voltage		V_{RRM}	350	V
Repetitive peak forward current		I_{FRM}	625	mA
Forward current		I_F	225	mA
Non-Repetitive peak forward surge current	Pulse width=1 μ s	I_{FSM}	4	A
	Pulse width=1s		1	
Junction temperature range		T_J	-65 to +150	°C
Storage temperature range		T_{STG}	-65 to +150	°C

THERMAL PERFORMANCE			
PARAMETER	SYMBOL	TYP	UNIT
Junction-to-ambient thermal resistance	$R_{\theta JA}$	357	$^{\circ}\text{C/W}$

ELECTRICAL SPECIFICATIONS ($T_A = 25^{\circ}\text{C}$ unless otherwise noted)					
PARAMETER	CONDITIONS	SYMBOL	MIN	MAX	UNIT
Forward voltage per diode ⁽¹⁾	$I_F = 100\text{mA}, T_J = 25^{\circ}\text{C}$	V_F	-	1.00	V
	$I_F = 200\text{mA}, T_J = 25^{\circ}\text{C}$			1.25	
Reverse voltage	$I_R = 100\ \mu\text{A}, T_J = 25^{\circ}\text{C}$	V_R	350	-	V
Reverse current @ rated V_R per diode ⁽²⁾	$V_R = 240\ \text{V}, T_J = 25^{\circ}\text{C}$	I_R	-	0.1	μA
	$V_R = 240\ \text{V}, T_J = 150^{\circ}\text{C}$			100	
Junction capacitance	$f=1\ \text{MHz}, V_R=1\text{V}$	C_J	-	5	pF
Reverse recovery time	$I_F=I_R=30\text{mA}, R_L=100\Omega,$ $I_{RR}=0.1I_R$	t_{rr}	-	50	ns

Notes:

1. Pulse test with $PW=0.3\ \text{ms}$
2. Pulse test with $PW=30\ \text{ms}$

ORDERING INFORMATION		
ORDERING CODE (Note 1)	PACKAGE	PACKING
MMBD300x RF	SOT-23	3K / 7" Reel
MMBD300x RFG	SOT-23	3K / 7" Reel

Note:

1. "xxx" defines part no. from "4" to "4SE"

CHARACTERISTICS CURVES

($T_A = 25^\circ\text{C}$ unless otherwise noted)

Fig.1 Typical Forward Characteristics

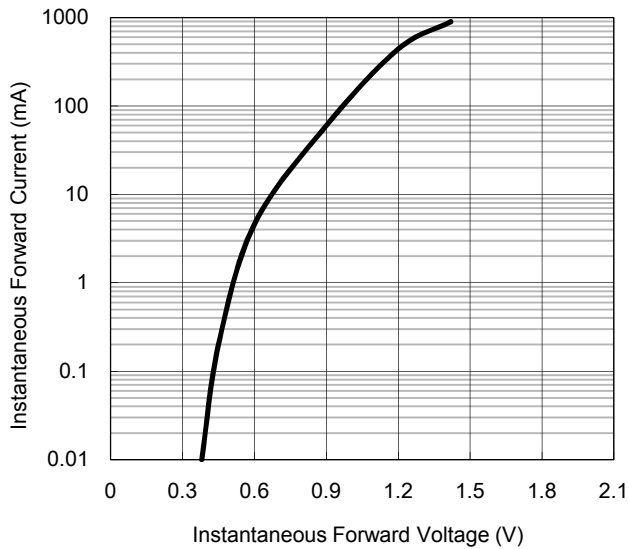

Fig. 2 Typical Reverse Characteristics

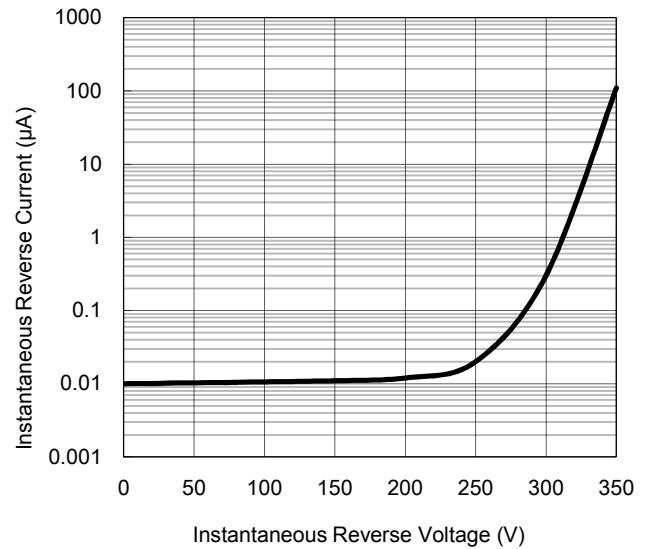

Fig.3 Admissible Power Dissipation Curve

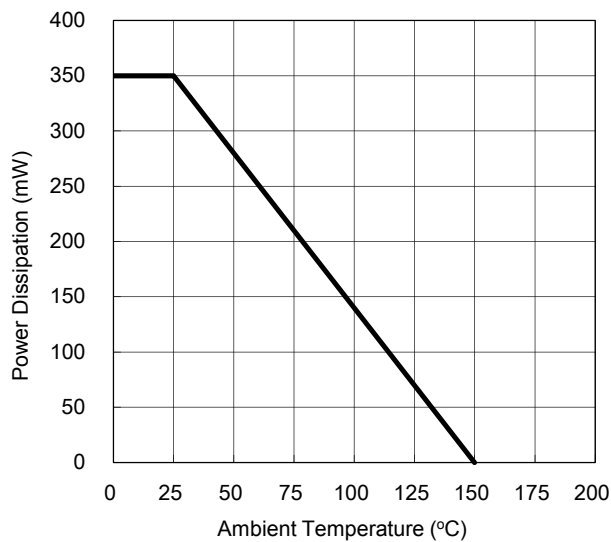
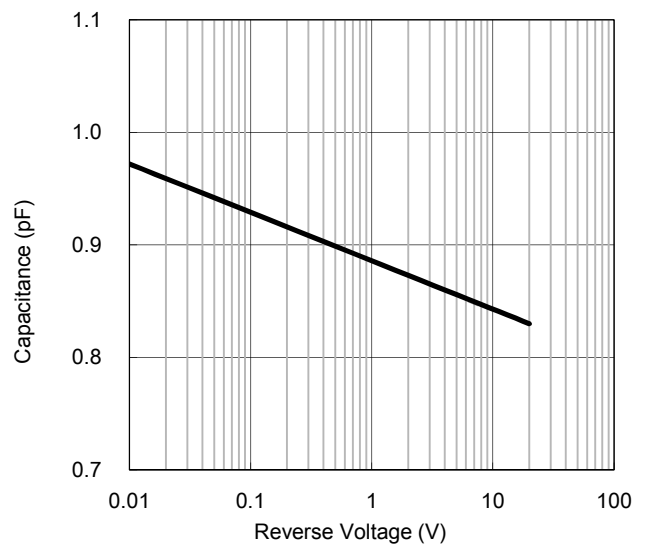
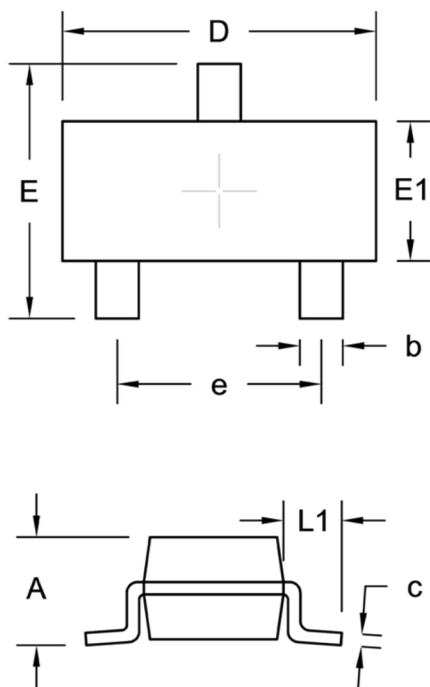

Fig.4 Typical Capacitance VS. Reverse Voltage



PACKAGE OUTLINE DIMENSION

SOT-23



DIM.	Unit (mm)		Unit (inch)	
	Min.	Max.	Min.	Max.
A	0.89	1.12	0.035	0.044
b	0.30	0.50	0.012	0.020
c	0.08	0.20	0.003	0.008
D	2.80	3.04	0.110	0.120
E	2.10	2.64	0.083	0.104
E1	1.20	1.40	0.047	0.055
e	1.90 BSC		0.075 BSC	
L1	0.54 REF.		0.021 REF.	

SUGGESTED PAD LAYOUT

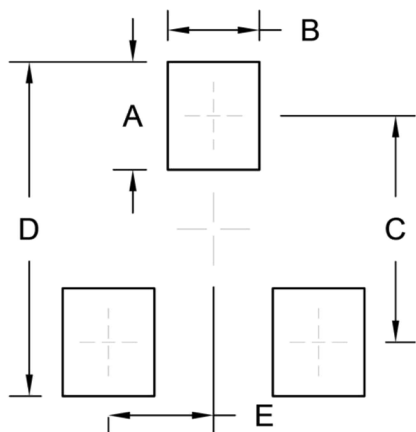

Symbol	Unit (mm)	Unit (inch)
A	1.00	0.039
B	0.85	0.033
C	2.10	0.083
D	3.10	0.122
E	0.98	0.039

PIN CONFIGURATION

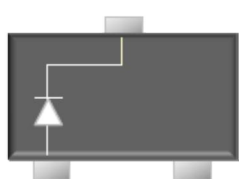

MMBD3004

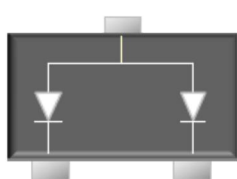

MMBD3004CA

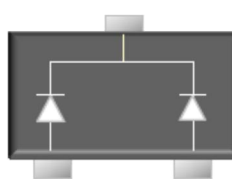

MMBD3004CC

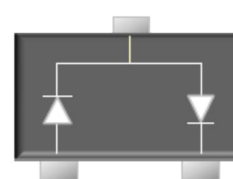

MMBD3004SE